

## DUAL OPERATIONAL AMPLIFIER

### ■ GENERAL DESCRIPTION

NJM4580 is the dual operational amplifier, specially designed for improving the tone control, which is most suitable for the audio application.

Featuring noiseless, higher gain bandwidth, high output current and low distortion ratio, and it is most suitable not only for acoustic electronic parts of audio pre-amp and active filter, but also for the industrial measurement tools. It is also suitable for the head phone amp at higher output current, and further more, it can be applied for the handy type set operational amplifier of general purpose in application of low voltage single supply type which is properly biased of the low voltage source.

### ■ FEATURES

- Operating Voltage (  $\pm 2V \sim \pm 18V$  )
- Low Input Noise Voltage (  $0.8\mu V_{rms}$  typ. )
- Wide Gain Bandwidth Product (  $15MHz$  typ. )
- Low Distortion (  $0.0005\%$  typ. )
- Slew Rate (  $5V/\mu s$  typ. )
- Package Outline DIP8, SIP8, EMP8, SSOP8, DMP8
- Bipolar Technology

### ■ PACKAGE OUTLINE

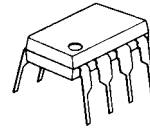

NJM4580D

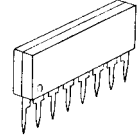

NJM4580L



NJM4580E



NJM4580V

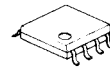

NJM4580M

### ■ PIN CONFIGURATION

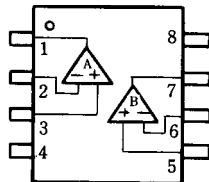

NJM4580D, NJM4580E  
NJM4580M, NJM4580V

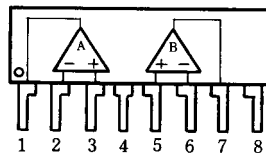

NJM4580L

### PIN FUNCTION

- 1. A OUTPUT
- 2. A -INPUT
- 3. A +INPUT
- 4.  $V^-$
- 5. B +INPUT
- 6. B -INPUT
- 7. B OUTPUT
- 8.  $V^+$

### ■ EQUIVALENT CIRCUIT ( 1/2 Shown )

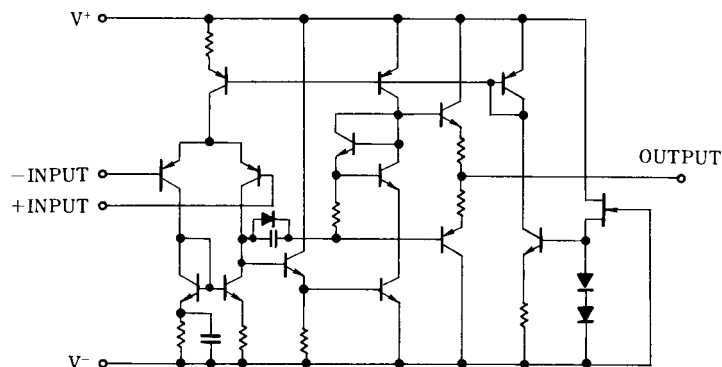

# NJM4580

## ■ ABSOLUTE MAXIMUM RATINGS

( Ta=25°C )

PARAMETER	SYMBOL	RATINGS	UNIT
Supply Voltage	$V^+V^-$	± 18	V
Input Voltage	$V_{IC}$	± 15 ( note )	V
Differential Input Voltage	$V_{ID}$	± 30 ( note )	V
Output Current	$I_o$	± 50	mA
Power Dissipation	$P_D$	( DIP8 ) 800 ( SIP8 ) 800 ( DMP8 ) 300 ( EMP8 ) 300 ( SSOP8 ) 250	mW
Operating Temperature Range	$T_{opr}$	-40~+85	°C
Storage Temperature Range	$T_{stg}$	-40~+125	°C

## ■ ELECTRICAL CHARACTERISTICS

( Ta=25°C,  $V^+V^- = \pm 15V$  )

PARAMETER	SYMBOL	TEST CONDITION	MIN.	TYP.	MAX.	UNIT
Input Offset Voltage	$V_{IO}$	$R_S \leq 10k\Omega$	-	0.5	3	mV
Input Offset Current	$I_{IO}$		-	5	200	nA
Input Bias Current	$I_B$		-	100	500	nA
Large Signal Voltage Gain	$A_V$	$R_L \geq 2k\Omega, V_O = \pm 10V$	90	110	-	dB
Output Voltage Swing	$V_{OM}$	$R_L \geq 2k\Omega$	± 12	± 13.5	-	V
Input Common Mode Voltage Range	$V_{ICM}$		± 12	± 13.5	-	V
Common Mode Rejection Ratio	CMR	$R_S \leq 10k\Omega$	80	110	-	dB
Supply Voltage Rejection Ratio	SVR	$R_S \leq 10k\Omega$	80	110	-	dB
Operating Current	$I_{CC}$		-	6	9	mA
Slew Rate	SR	$R_L \geq 2k\Omega$	-	5	-	V/ $\mu$ s
Gain Bandwidth Product	GB	$f = 10kHz$	-	15	-	MHz
Total Harmonic Distortion	THD	$A_V = 20dB, V_O = 5V, R_L = 2k\Omega, f = 1kHz$	-	0.0005	-	%
Input Noise Voltage	$V_{NI}$	RIAA, $R_S = 2.2k\Omega, 30kHz$ LPF	-	0.8	-	$\mu$ Vrms

## ■ TYPICAL CHARACTERISTICS

**Maximum Output Voltage Swing vs. Load Resistance**

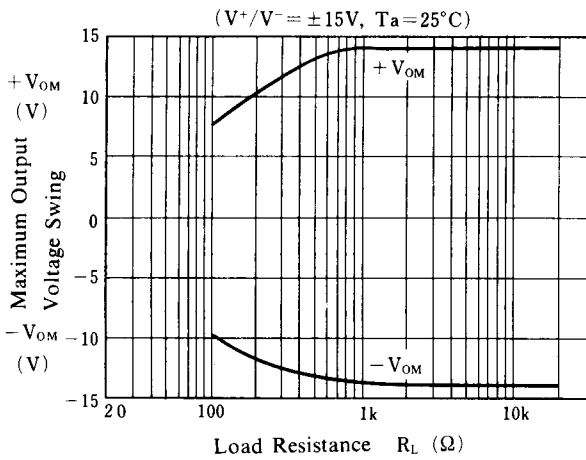

**Maximum Output Voltage Swing vs. Frequency**

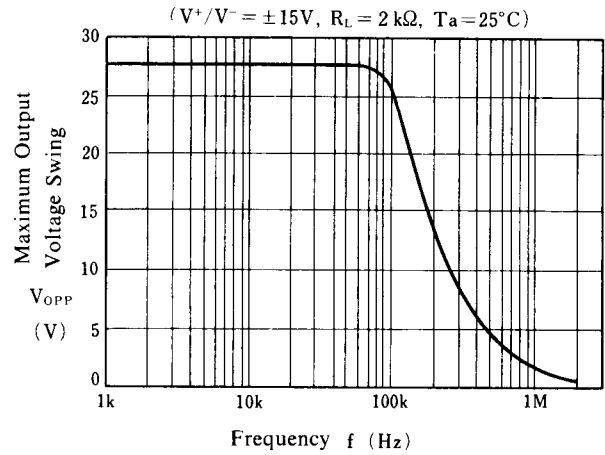

**Output Voltage Swing vs. Output Current**

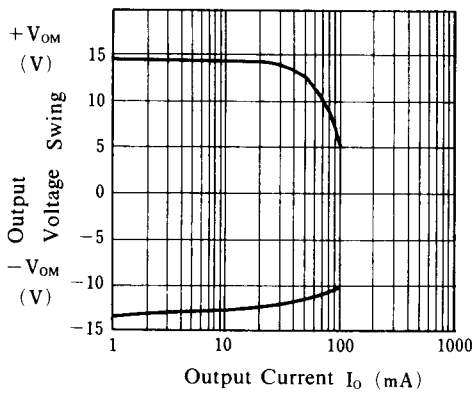

**Equivalent Input Noise Voltage vs. Frequency**

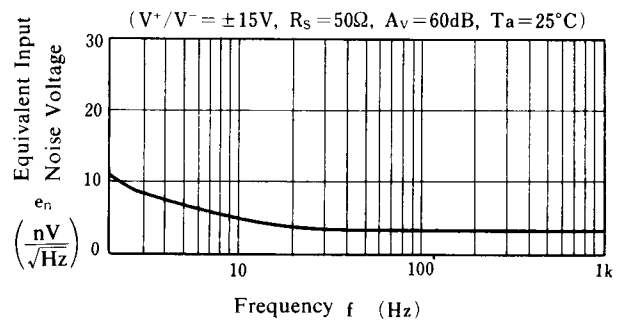

**Operating Current vs. Temperature**

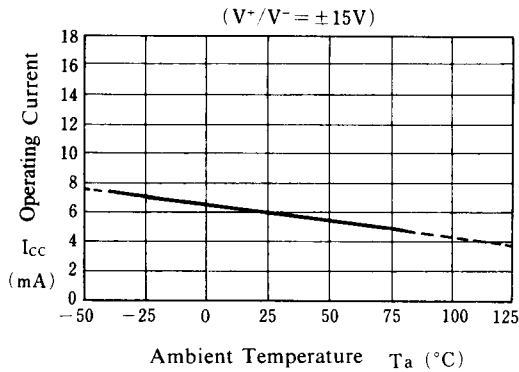

**Output Voltage Swing vs. Temperature**

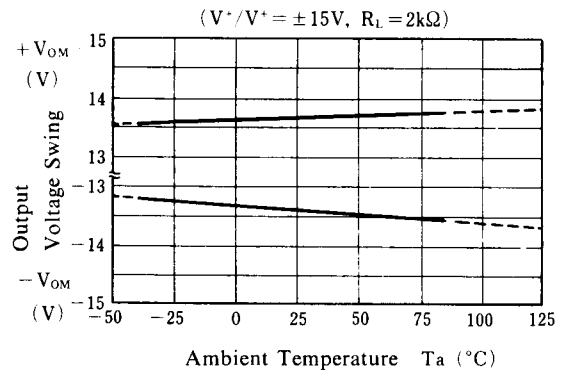

## ■ TYPICAL CHARACTERISTICS

**Input Offset Voltage vs. Temperature**

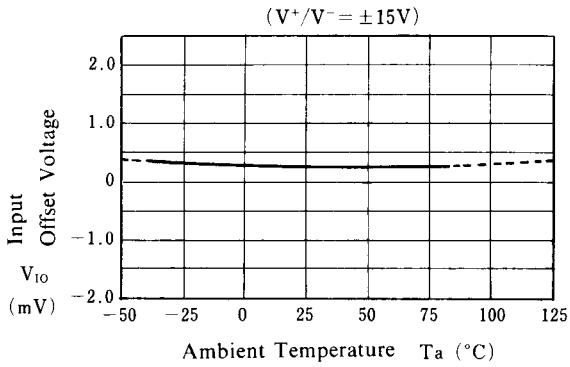

**Input Bias Current vs. Temperature**

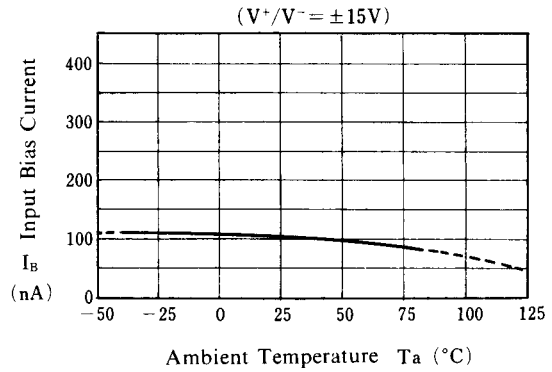

**Maximum Output Voltage Swing vs. Operating Voltage**

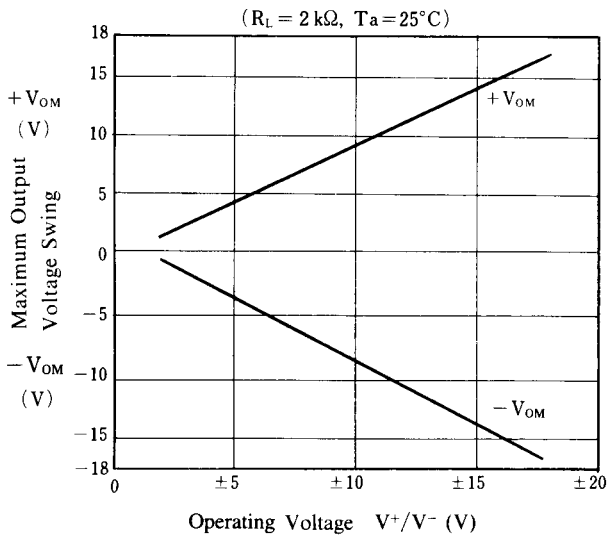

**Operating Current vs. Operating Voltage**

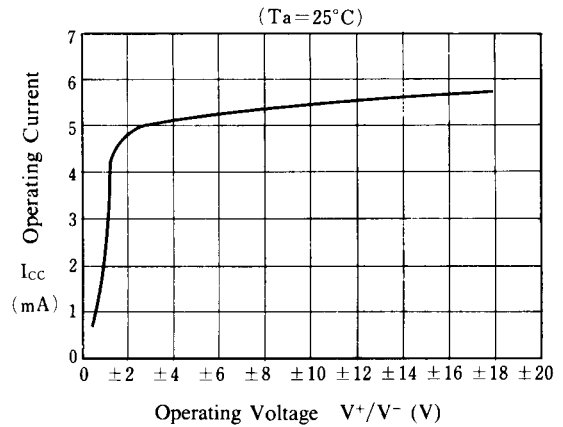

**Total Harmonic Distortion vs. Output Voltage**

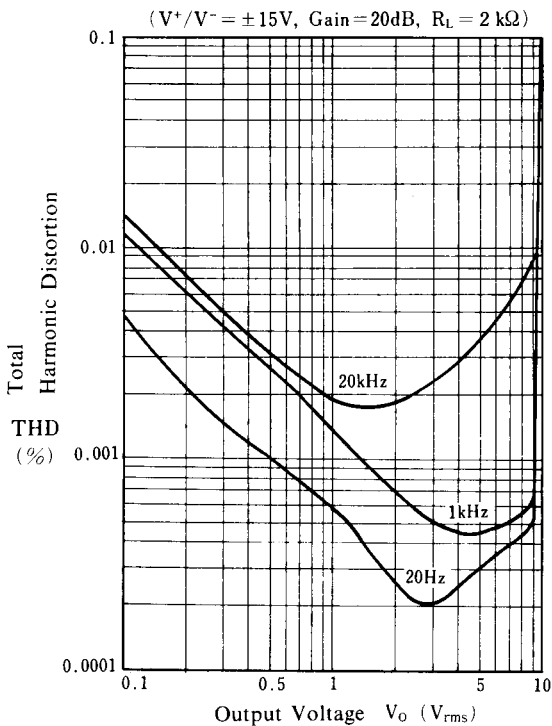

**Voltage Gain, Phase vs. Frequency**

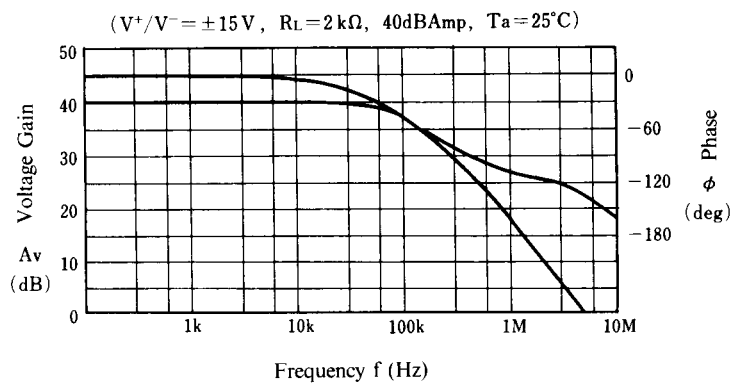

**[CAUTION]**  
 The specifications on this databook are only given for information, without any guarantee as regards either mistakes or omissions. The application circuits in this databook are described only to show representative usages of the product and not intended for the guarantee or permission of any right including the industrial rights.